



晶采光電科技股份有限公司
AMPIRE CO., LTD.

SPECIFICATIONS FOR LCD MODULE

CUSTOMER	
CUSTOMER PART NO.	
AMPIRE PART NO.	AM-1280800W8TZQW-T00H
APPROVED BY	
DATE	

Preliminary Specification

Approved Specification

AMPIRE CO., LTD.

**4F., No.116, Sec. 1, Xintai 5th Rd., Xizhi Dist., New Taipei
City221, Taiwan (R.O.C.)**

新北市汐止區新台五路一段 116 號 4 樓(東方科學園區 A 棟)

TEL:886-2-26967269 , FAX:886-2-26967196 or 26967270

APPROVED BY	CHECKED BY	ORGANIZED BY
<i>Patrick</i>	<i>Kokai</i>	<i>Mark</i>

This specification is subject to change without notice

RECORD OF REVISION

Revision Date	Page	Contents	Editor
2021/04/26	--	New Release	Mark

1.0 General Descriptions

1.1 Introduction

The LCM is a color active matrix thin film transistor (TFT) liquid crystal display (LCD) that uses amorphous silicon TFT as a switching device. It is composed of a TFT LCD panel, a backlight system, column driver and row driver circuit. This TFT LCD has a 10.1-inch diagonally measured active display area with WXGA resolution (1280 horizontal by 800 vertical pixels array).

1.2 Features

- 10.1" TFT LCD Panel
- LED Backlight System
- Supported WXGA 1280x800 pixels resolution
- Compatible with RoHS Standard
- **Touch Panel:**
 - **Controller: EXC80W32**
 - **Interface: USB**
 - **Cover Glass:None**

1.3 Product Summary

Items	Specifications	Unit
Screen Diagonal	10.1	Inch
Active Area	216.96(H) x 135.6(V)	mm
Pixel Format	1280(RGB) x800	-
Pixel Pitch	0.1695(H)×0.1695 (V)	mm
Pixel Arrangement	R.G.B. Vertical Stripe	-
Display Mode	Normally Black	-
White Luminance	295(Typ)	cd /m2
Contrast Ratio	800 : 1 (Typ)	-
Response Time	25	msec
Input Voltage	3.3	V
Weight	160 (Max)	g
Electrical Interface (Logic)	LVDS	-
Support Color	16.7M	-
Surface Treatment	Glare, Hard-Coating (3H)	-

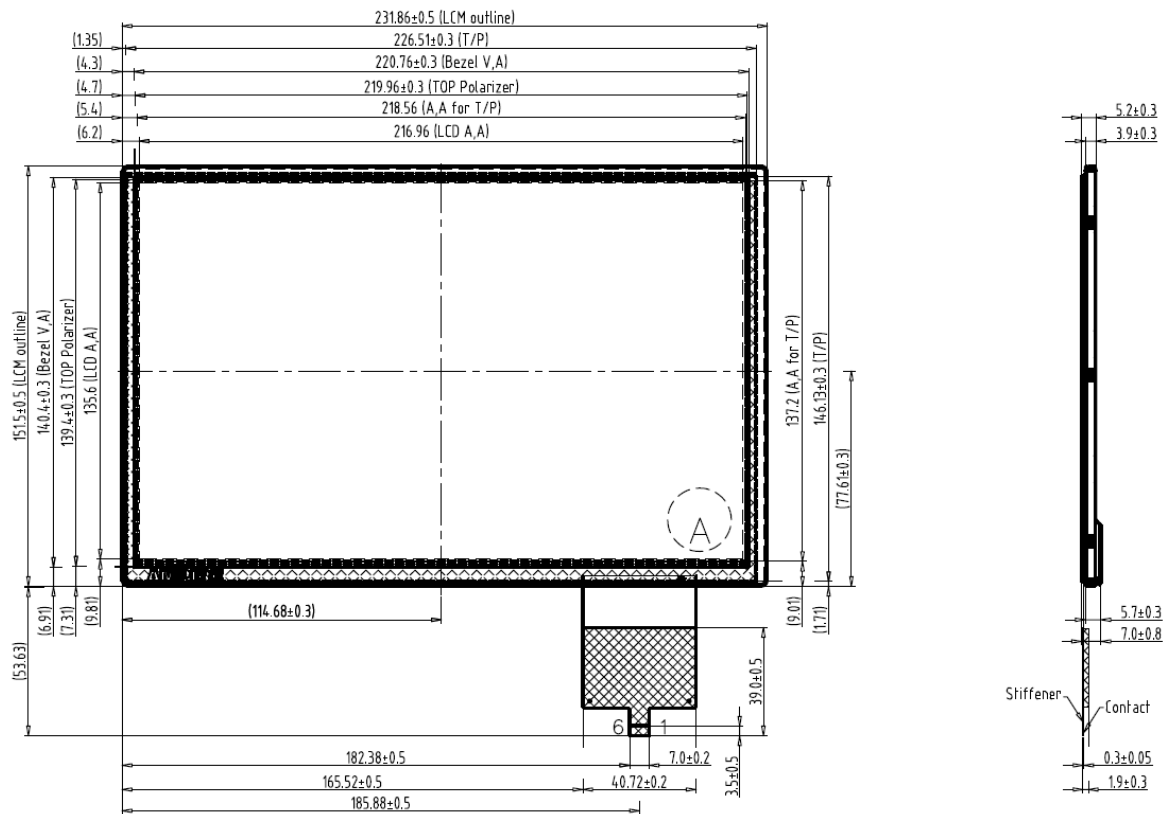

1.4 Functional Block Diagram

Shows the functional block diagram of the LCD module.

Figure 1 Block Diagram

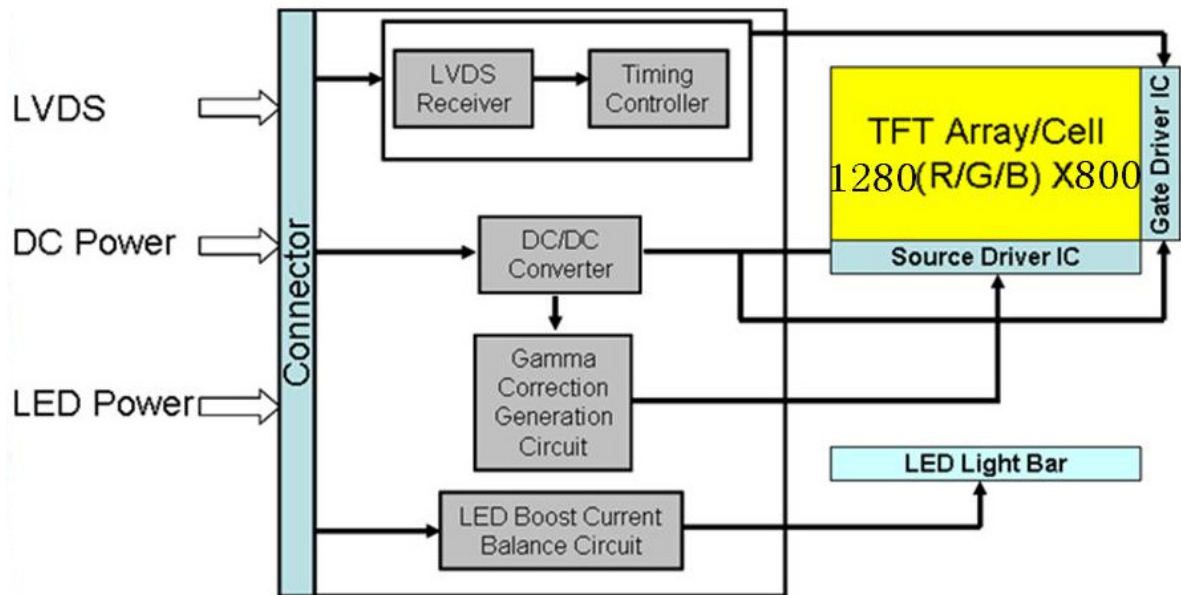

2.0 Absolute Maximum Ratings

Table 1 Electrical Absolute Ratings

Item	Symbol	Min	Max	Unit	Conditons
Logic Supply Voltage	VDD	-0.3	4.0	V	TA=25°C
Supply VLED Voltage	VLED	-0.3	24	V	TA=25°C

Table 2 Reliability Absolute Ratings

Item	Symbol	Min	Max	Unit	Conditons
Operating Temperature	TOP	-20	70	°C	Note
Operating Humidity	HOP	--	90	%RH	Note
Storage Temperature	TST	-30	80	°C	Note
Storage Humidity	HST	--	90	%RH	Note

Note: (1) Maximum Wet-Bulb temperature should be 39 degree C and no condensation.

(2) When you apply the LCD module for OA system. Please make sure to keep the temperature of LCD module is less than 70°C

(3) Storage /Operating temperature

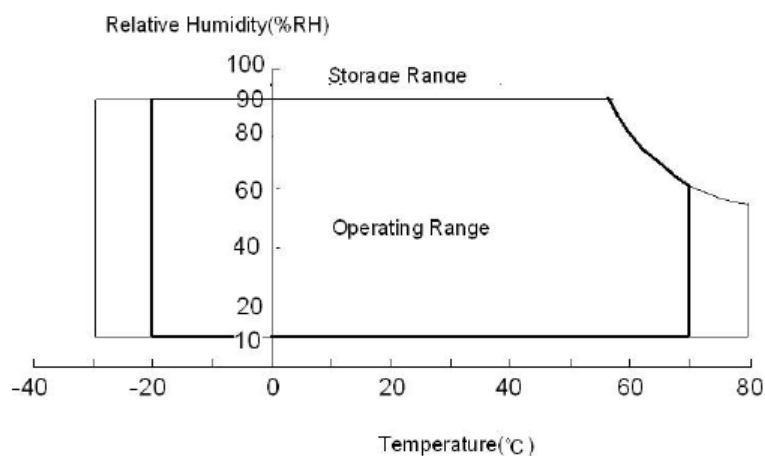

3.0 Pixel Format Image

Figure 2 shows the relationship of the input signals and LCD pixel format image.

Figure 2 Pixel Format

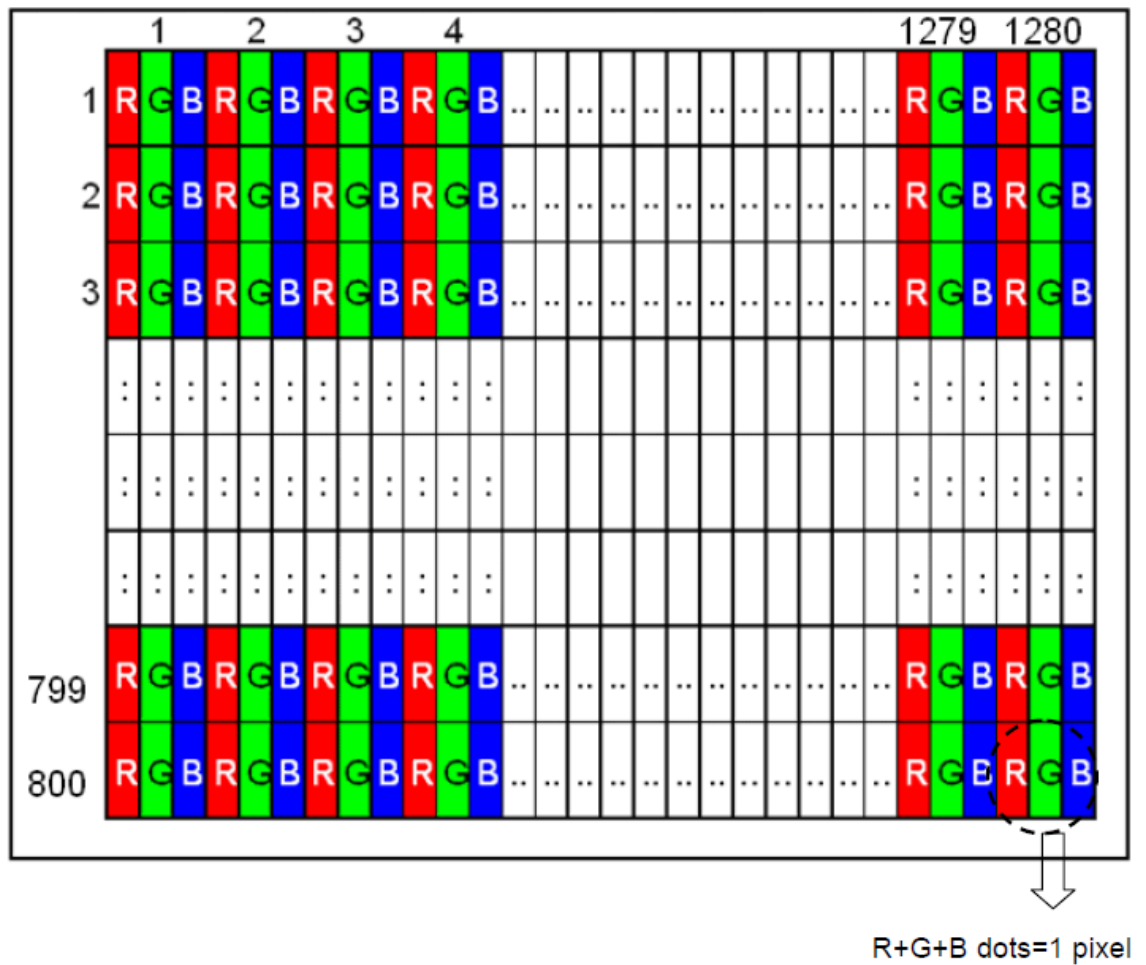

4.0 Optical Characteristics

The optical characteristics are measured under stable conditions as following notes

Table 2 Optical Characteristics

Item	Conditions		Min.	Typ.	Max.	Unit	Note	
Viewing Angle (CR>10)	Horizontal	θ_L	(75)	(85)	-	degree	(1),(2),(3)	
		θ_R	(75)	(85)	-			
	Vertical	θ_T	(75)	(85)	-			
		θ_B	(75)	(85)	-			
Contrast Ratio	Center		(600)	(800)	-	-	(1),(2),(4)	
Response Time	Rising		-	-	-	ms	(1),(2),(5)	
	Falling		-	-	-	ms		
	Rising + Falling		-	25	-	ms		
Color Chromaticity (CIE1931)	NTSC		-	45	-	%	(1),(2)	
	Red	x	Typ. -0.03	0.561	Typ. +0.03	-	(1),(2)	
	Red	y		0.334		-		
	Green	x		0.341		-		
	Green	y		0.568		-		
	Blue	x		0.161		-		
	Blue	y		0.129		-		
	White	x		-		0.313		-
White	y	-		0.329		-		-
White Luminance	Center		255	295	-	cd/m ²	(1),(2),(6)	
Luminance Uniformity	9Points		70	75	-	%	(1),(2),(6)	

Note(1) Measurement Setup:

The LCD module should be stabilized at given temperature(25°C) for 15 minutes to Avoid abrupt temperature change during measuring. In order to stabilize the luminance, the measurement should be executed after lighting backlight for 15 minutes in a windless room.

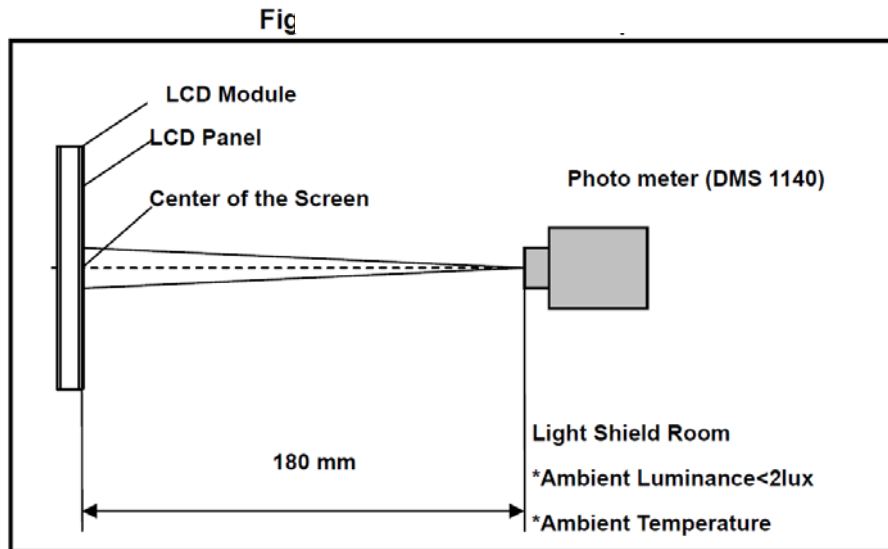

Note(2) The LED input parameter setting as: PWM: duty 100 %

Note(3) Definition of viewing angle:

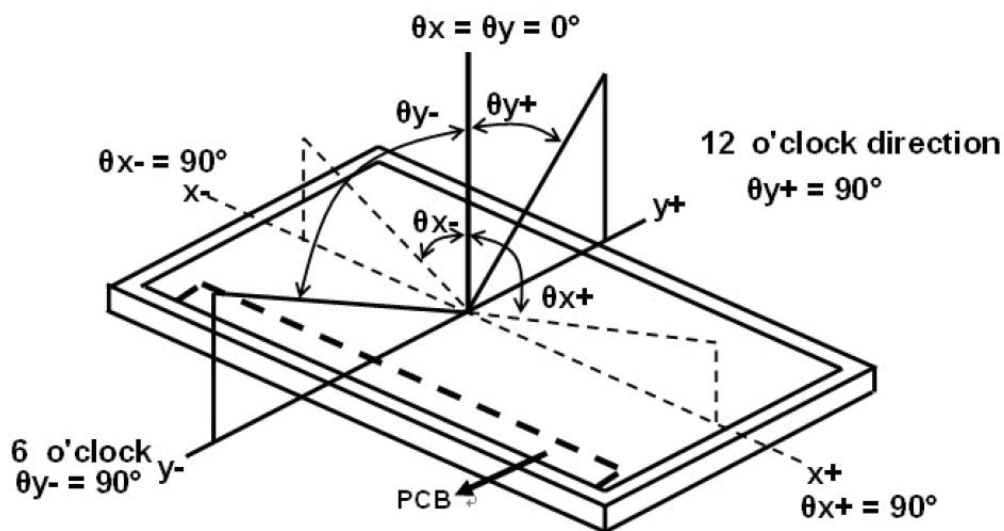

Note(4) Definition of Contrast Ratio (CR)

The contrast ratio can be calculated by the following expression

$$\text{Contrast Ratio (CR)} = L_{255} / L_0$$

L_{63} : Luminance of gray level 255, L_0 : Luminance of gray level 0

Note(5) Definition of Response Time (TR, TF)

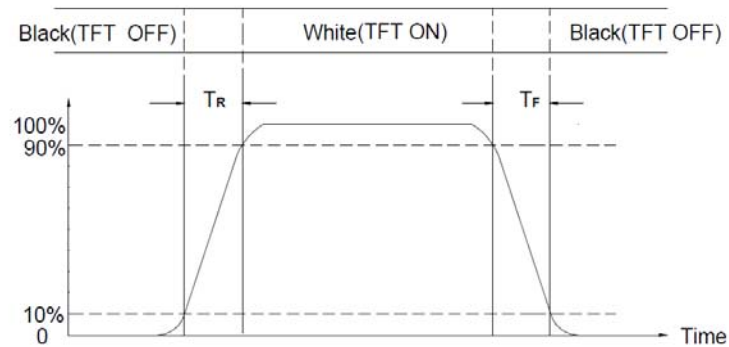

Note(6) Definition of brightness luminance

Active area is divided into 9 measuring areas (Refer to bellow figure).
 Every measuring point is placed at the center of each measuring area.

$$\text{Luminance Uniformity (Yu)} = \frac{B_{\min}}{B_{\max}}$$

L ----- Active area length W ----- Active area width

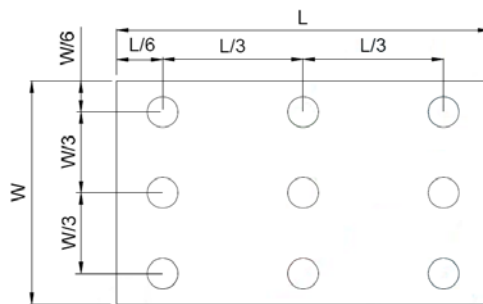

Bmax: The measured maximum luminance of all measurement position.
 Bmin: The measured minimum luminance of all measurement position.

5.0 Backlight Characteristics

5.1 Parameter Guideline Of LED Backlight

Table 3 Parameter Guideline for LED Backlight

Symbol	Parameter	Min.	Typ.	Max.	Units	Condition	
VLED	LED Input	(6)	(12)	(21)	[V]	Ta=25°C Note B	
PLED	LED Power Consumption	-	-	(2.5)	W	Ta=25°C Note B	
VLED_PWM	PWM Signal Voltage	High	3.0	--	3.6	V	Ta=25°C
		Low	0	--	0.4	V	
FPWM	PWM dimming Frequency		100	-	200	Hz	D _{DIM} ≥0.1%
			200	-	500		D _{DIM} ≥0.25%
			500	-	1000		D _{DIM} ≥0.5%
			1000	-	2000		D _{DIM} ≥1%
			2000	-	5000		D _{DIM} ≥2.5%
			5000	-	10000		D _{DIM} ≥5%
			10000	-	20000		D _{DIM} ≥10%
			20000	-	30000		D _{DIM} ≥15%
VLED_EN	LED Enable Voltage	High	3.0	--	3.6	V	-
		Low	0	--	0.4	V	
LT	LED Life Time	20,000	25,000	-	Hours	Ta=25°C Note A	

Note A: The LED life time define as the estimated time to 50% degradation of initial luminous.

Note B: A higher LED power supply voltage will result in better power efficiency.
Keep the VLED between 12V and 12.6V is strongly recommended.

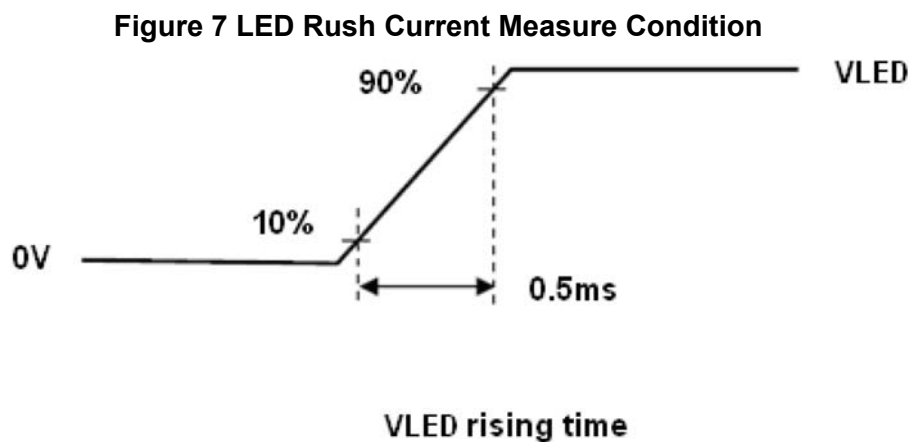

6.0 Electrical Characteristics

6.1 TFT LCD Module Interface Connector

Table 4 Connector Name / Designation

Item	Description
Manufacturer / Part Number	Starconn / 300E40-0010RA-G3
Mating Model Number	TBD or compatible

Table 5 Signal Pin Assignment

Pin #	Signal Name	Description	Remarks
1	NC	Not Connect	-
2	VDD	Power Supply, 3.3V (typical)	-
3	VDD	Power Supply, 3.3V (typical)	
4	VDD_EDID	Power Supply for EDID I2C Flash IC	
5	SCL_EDID	I2C Serial Clock for EDID I2C Flash IC	
6	SDA_EDID	I2C Serial Data for EDID I2C Flash IC	
7	NC	Not Connect	
8	LV0N	-LVDS differential data input	
9	LV0P	+LVDS differential data input	
10	GND	Ground	
11	LV1N	-LVDS differential data input	
12	LV1P	+LVDS differential data input	
13	GND	Ground	
14	LV2N	-LVDS differential data input	
15	LV2P	+LVDS differential data input	
16	GND	Ground	
17	LVCLKN	-LVDS differential data input	
18	LVCLKP	+LVDS differential data input	
19	GND	Ground	
20	LV3N	-LVDS differential data input	
21	LV3P	+LVDS differential data input	
22	GND	Ground	
23	LED_GND	Ground for LED Driving	
24	LED_GND	Ground for LED Driving	
25	LED_GND	Ground for LED Driving	
26	NC	Not Connect	
27	LED_PWM	PWM Input signal for LED driver	
28	LED_EN	LED Enable Pin	
29	NC	Not Connect	
30	NC	Not Connect	
31	LED_VCC	Power Supply for LED Driver	
32	LED_VCC	Power Supply for LED Driver	
33	LED_VCC	Power Supply for LED Driver	
34	NC	Not Connect	
35	BIST	BIST pin. (Keep NC or GND if not use.)	NC
36	NC	Not Connect	NC
37	NC	Not Connect	NC
38	NC	Not Connect	NC
39	NC	Not Connect	NC
40	NC	Not Connect	NC

Note: All input signals shall be low or Hi-resistance state when VDD is off.

6.2 LVDS Receiver

6.2.1 Signal Electrical Characteristics For LVDS Receiver

Table 7 LVDS Receiver Electrical Characteristics

Parameter	Symbol	Min.	Typ.	Max.	Unit	Conditions
Differential Input High	V_{th}	-	-	+100	mV	$V_{CM}=+1.2V$
Differential Input Low	V_{tl}	-100	-	-	mV	$V_{CM}=+1.2V$
Magnitude Differential Input	$ V_{ID} $	200	-	400	mV	-
Common Mode Voltage	V_{CM}	$0.3+(V_{ID}/2)$	-	$V_{DD}-1.2-(V_{ID}/2)$	V	-
Common Mode Voltage	ΔV_{CM}	-	-	50	mV	$V_{CM}=+1.2V$

Note (1) Input signals shall be low or Hi-Z state when VDD is off.

(2) All electrical characteristics for LVDS signal are defined and shall be measured at the interface connector of LCD.

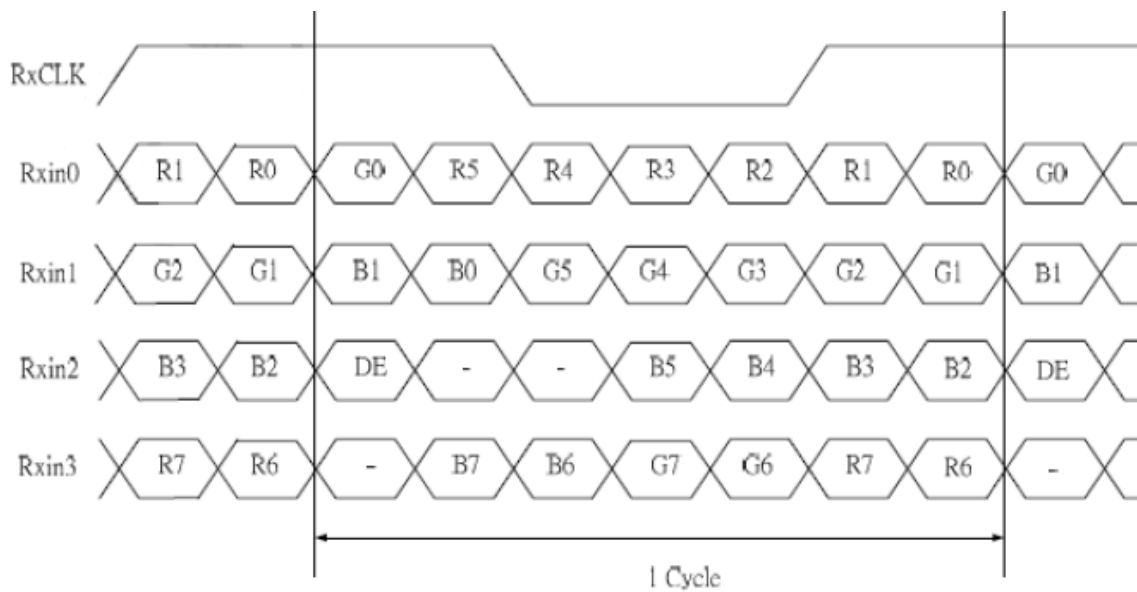
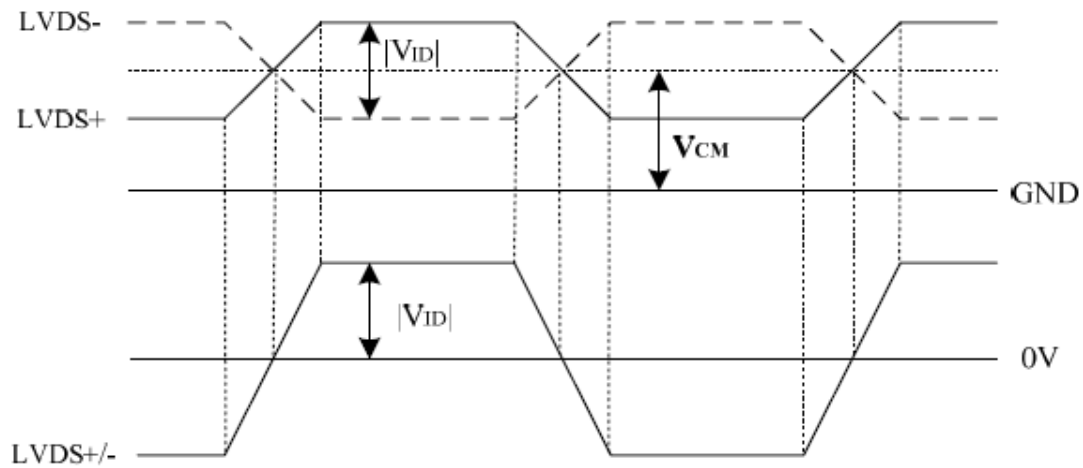

7.0 Interface Timings

7.1 Timing Characteristics

Interface Timings

Parameter	Symbol	Min.	Typ.	Max.	Unit
LVDS Clock Frequency	Fclk	(70.0)	(72.4)	(76.6)	MHz
H Total Time	HT	(1,410)	(1,440)	(1,470)	Clocks
H Active Time	HA		1,280		Clocks
V Total Time	VT	(828)	(838)	(868)	Lines
V Active Time	VA		800		Lines
Frame Rate	FV	-	(60)	-	Hz

Note1: $HT * VT * \text{Frame Frequency} \leq (76.6) \text{ MHz}$

Note2: All reliabilities are specified for timing specification based on refresh rate of 60Hz.

7.2 Timing Diagram of Interface Signal (DE mode)

Figure 8 Timing Characteristics

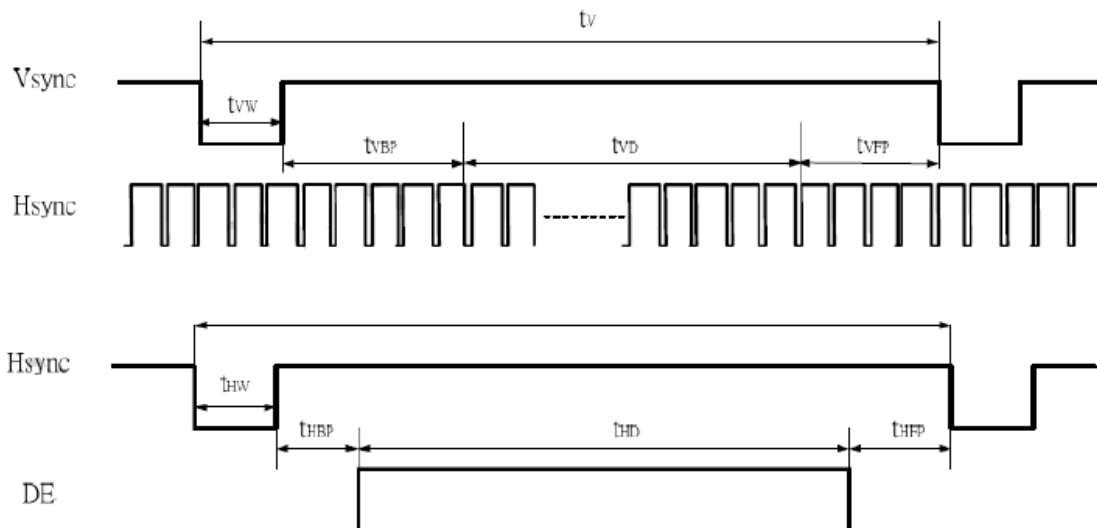

8.0 Power Consumption

Input power specifications are as follows.

Table 8 Power Consumption

Item	Symbol	Min	Typ	Max	Unit	Note
LCD Drive Voltage	VDD	3.0	3.3	3.6	V	(3)
VDD Current	White Pattern IDD	--	0.295	--	A	(2),(3)
VDD Power Consumption	White Pattern PDD	--	--	1.2	W	(2),(3)
LED Power Consumption	PLED			2.5	W	(2),(3)
Rush Current	Irush			1.5	A	(1),(3),(4)
Allowable Logic/LCD Drive Ripple Voltage	VDDrp			300	mV	(3)

Note (1) Measure Condition

Figure 9 VDD rising time

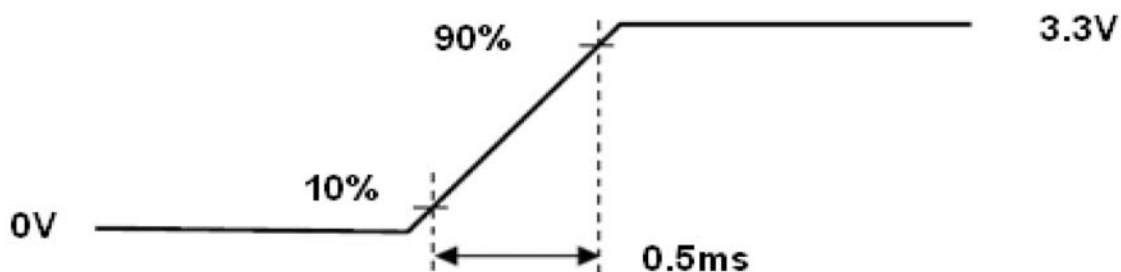

VDD rising time

Note (2) Frame Rate=60Hz, VDD=3.3V,DC Current.

Note (3) Operating temperature 25°C , humidity 55%RH.

Note (4) The reference measurement circuit of rush current.

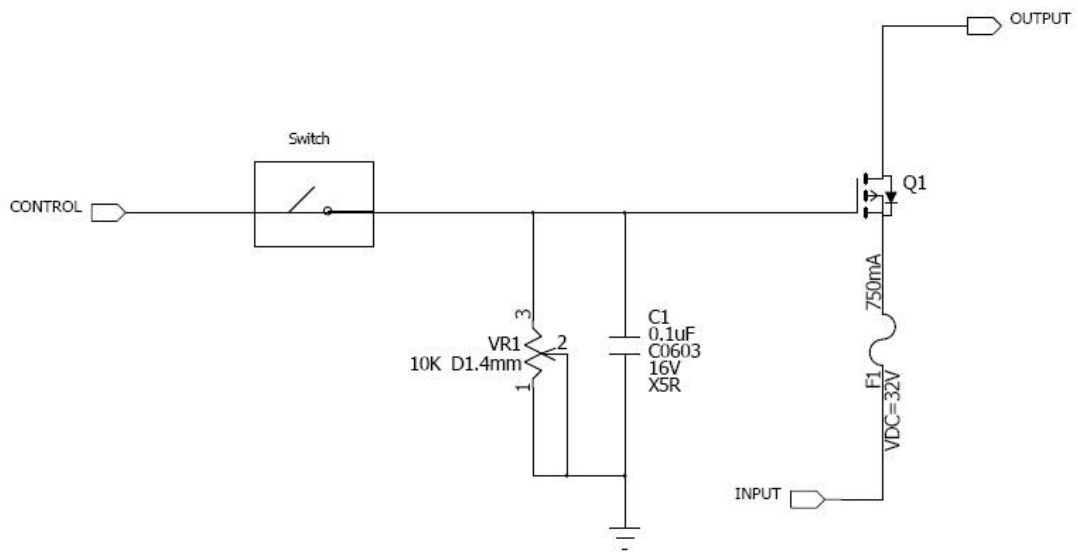

8.1 Power ON/OFF Sequence

Power on/off sequence is as follows. Interface signals are also shown in the chart. Signals from any system shall be Hi-Z state or low level when VDD is off.

Figure 11 Power Sequence

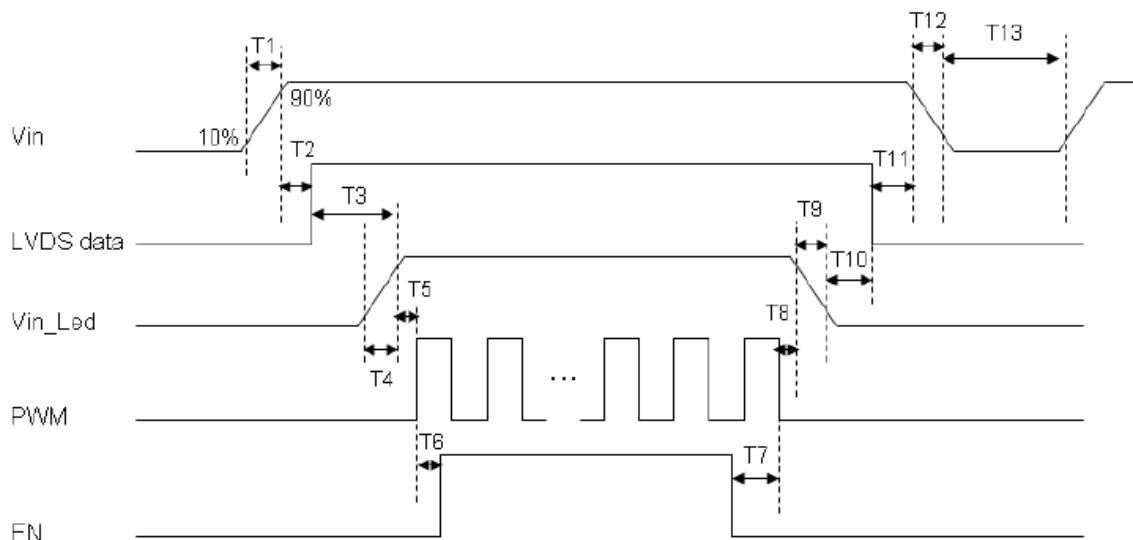

Table 9 Power Sequencing Requirements

Parameter	Symbol	Unit	Min	Typ.	Max
VIN Rise Time	T1	ms	0.5	--	10
VIN Good to Signal Valid	T2	ms	30	--	90
Signal Valid to Backlight On	T3	ms	200	--	--
Backlight Power On Time	T4	ms	0.5	--	--
Backlight VDD Good to System PWM On	T5	ms	10	--	--
System PWM ON to Backlight Enable ON	T6	ms	10	--	--
Backlight Enable Off to System PWM Off	T7	ms	0	--	--
System PWM Off to B/L Power Disable	T8	ms	10	--	--
Backlight Power Off Time	T9	ms	--	10	30
Backlight Off to Signal Disable	T10	ms	200	--	--
Signal Disable to Power Down	T11	ms	0	--	50
VIN Fall Time	T12	ms	--	10	30
Power Off	T13	ms	500	--	--

9.0 Projected capacitive-type Touch panel specification

9.1 Basic Characteristic

ITEM	SPECIFICATION
Type	Projective Capacitive Touch Panel
Activation	Two-fingers or Signal-finger
X/Y Position Reporting	Absolute Position
Touch Force	No contact pressure required
Calibration	No need for calibration
Report Rate	Approx 100 points/sec
Control IC	EETI EXC80W32

9.2 Interface

CN6		
Pin No.	Symbol	Function
1	VDD	USB POWER 5V
2	D+	USB Data+
3	D-	USB Data-
4	NC	No connect
5	GND	GND
6	GND	GND

TP needs to work in environment with stable stray capacitance. In order to minimize the variation in stray capacitance, all conductive mechanical parts must not be floating. Intermittent floating any conductive part around the touch sensor may cause significant stray capacitance change and abnormal touch function. It is recommended to keep all conductive parts having same electrical potential as the GND of the touch controller module.

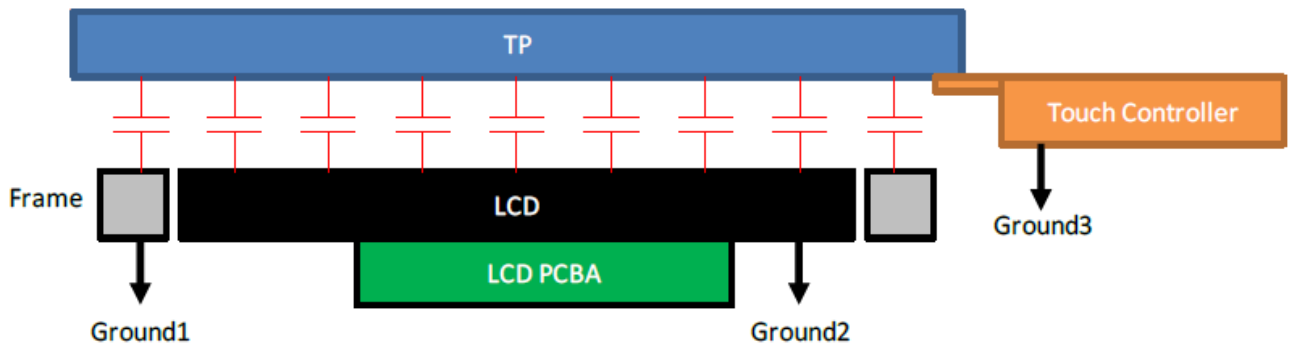

GND1, GND2 and GND3 should be connected together to have the same ground

10 USE PRECAUTIONS

10.1 Handling precautions

- 1) The polarizing plate may break easily so be careful when handling it. Do not touch, press or rub it with a hard-material tool like tweezers.
- 2) Do not touch the polarizing plate surface with bare hands so as not to make it dirty. If the surface or other related part of the polarizing plate is dirty, soak a soft cotton cloth or chamois leather in benzine and wipe off with it. Do not use chemical liquids such as acetone, toluene and isopropyl alcohol. Failure to do so may bring chemical reaction phenomena and deteriorations.
- 3) Remove any spit or water immediately. If it is left for hours, the suffered part may deform or decolorize.
- 4) If the LCD element breaks and any LC stuff leaks, do not suck or lick it. Also if LC stuff is stuck on your skin or clothing, wash thoroughly with soap and water immediately.

10.2 Installing precautions

- 1) The PCB has many ICs that may be damaged easily by static electricity. To prevent breaking by static electricity from the human body and clothing, earth the human body properly using the high resistance and discharge static electricity during the operation. In this case, however, the resistance value should be approx. $1M\Omega$ and the resistance should be placed near the human body rather than the ground surface. When the indoor space is dry, static electricity may occur easily so be careful. We recommend the indoor space should be kept with humidity of 60% or more. When a soldering iron or other similar tool is used for assembly, be sure to earth it.
- 2) When installing the module and ICs, do not bend or twist them. Failure to do so may crack LC element and cause circuit failure.
- 3) To protect LC element, especially polarizing plate, use a transparent protective plate (e.g., acrylic plate, glass etc) for the product case.
- 4) Do not use an adhesive like a both-side adhesive tape to make LCD surface (polarizing plate) and product case stick together. Failure to do so may cause the polarizing plate to peel off.

10.3 Storage precautions

- 1) Avoid a high temperature and humidity area. Keep the temperature between 0°C and 35°C and also the humidity under 60%.
- 2) Choose the dark spaces where the product is not exposed to direct sunlight or fluorescent light.
- 3) Store the products as they are put in the boxes provided from us or in the same conditions as we recommend.

10.4 Operating precautions

- 1) Do not boost the applied drive voltage abnormally. Failure to do so may break ICs. When applying power voltage, check the electrical features beforehand and be careful. Always turn off the power to the LC module controller before removing or inserting the LC module input connector. If the input connector is removed or inserted while the power is turned on, the LC module internal circuit may break.
- 2) The display response may be late if the operating temperature is under the normal standard, and the display may be out of order if it is above the normal standard. But this is not a failure; this will be restored if it is within the normal standard.
- 3) The LCD contrast varies depending on the visual angle, ambient temperature, power voltage etc. Obtain the optimum contrast by adjusting the LC drive voltage.
- 4) When carrying out the test, do not take the module out of the low-temperature space suddenly. Failure to do so will cause the module condensing, leading to malfunctions.
- 5) Make certain that each signal noise level is within the standard (L level: 0.2V_{dd} or less and H level: 0.8V_{dd} or more) even if the module has functioned properly. If it is beyond the standard, the module may often malfunction. In addition, always connect the module when making noise level measurements.
- 6) The CMOS ICs are incorporated in the module and the pull-up and pull-down function is not adopted for the input so avoid putting the input signal open while the power is ON.

- 7) The characteristic of the semiconductor element changes when it is exposed to light emissions, therefore ICs on the LCD may malfunction if they receive light emissions. To prevent these malfunctions, design and assemble ICs so that they are shielded from light emissions.
- 8) Crosstalk occurs because of characteristics of the LCD. In general, crosstalk occurs when the regularized display is maintained. Also, crosstalk is affected by the LC drive voltage. Design the contents of the display, considering crosstalk.

10.5 Other

- 1) Do not disassemble or take the LC module into pieces. The LC modules once disassembled or taken into pieces are not the guarantee articles.
- 2) Do not keep the LCD at the same display pattern continually. The residual image will happen and it will damage the LCD. Please use screen saver.
- 3) AMIPRE will provide one year warrantee for all products and three months warrantee for all repairing products.

10.6 Mechanism

(1) Please mount LCD module by using mounting holes arranged in four corners tightly.

(2) The square adhesive tape which is between the touch panel and display can't provide well supporting in the long term and high ambient temperature condition. Whether upright or horizontal position the support holder which is in the back side of the display is needed. Do not let the display floating.

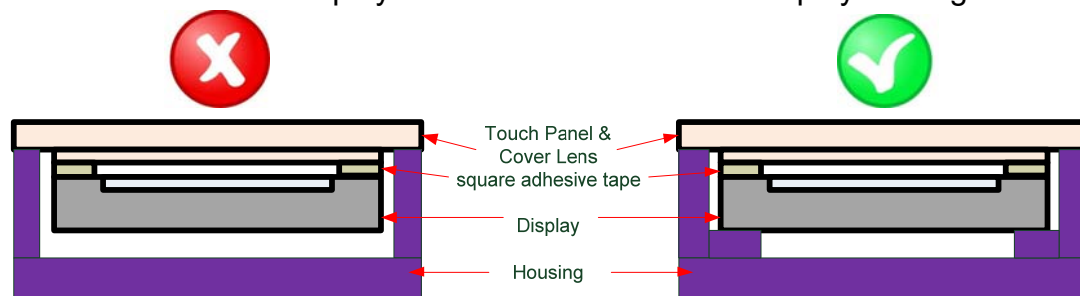

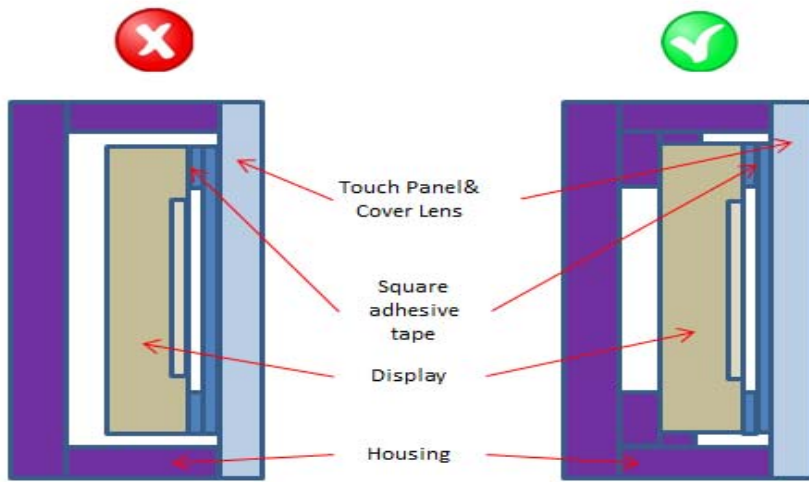

11 MECHANIC DRAWING

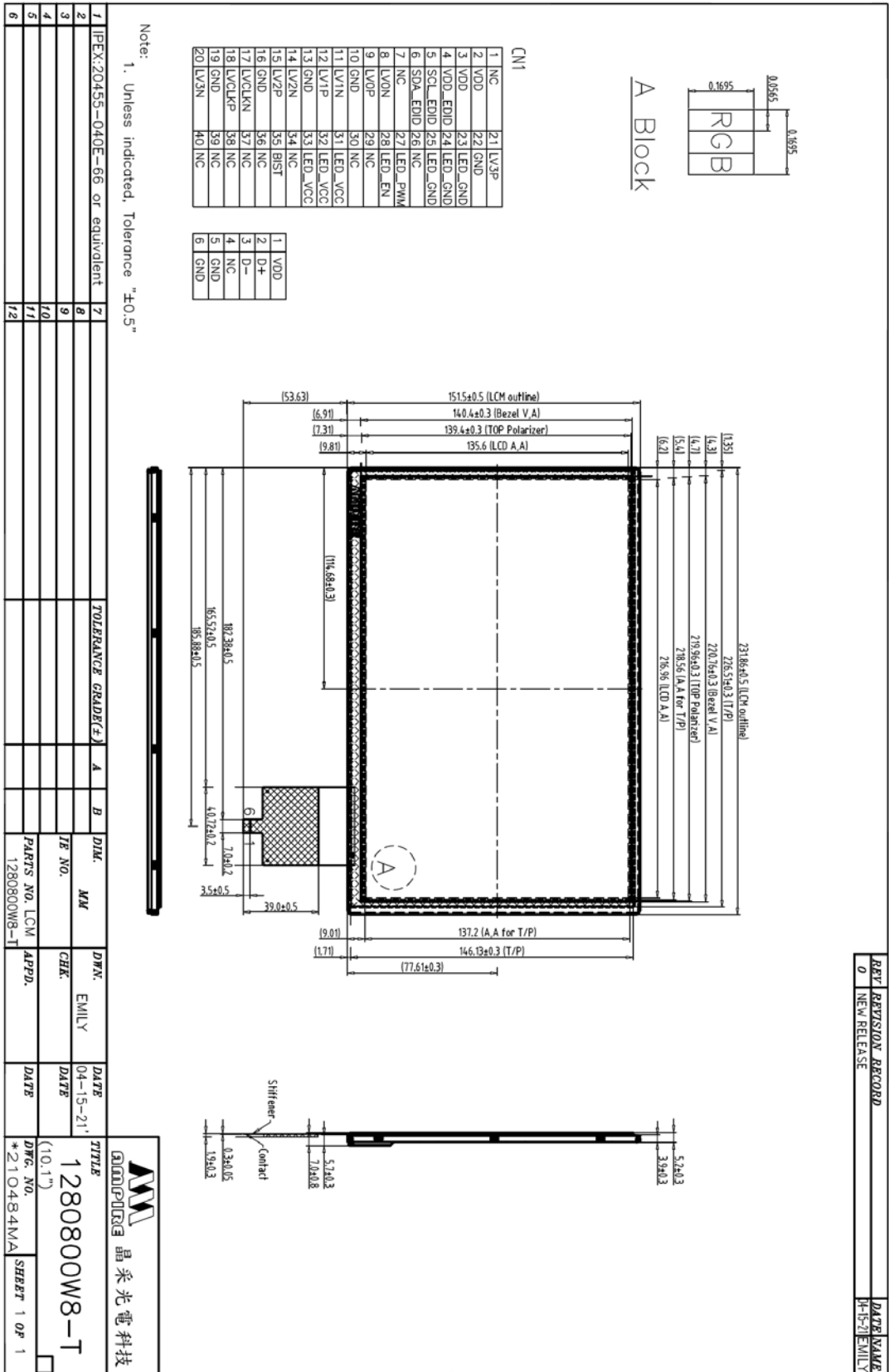

REV	REVISION RECORD	DATE	NAME
0	NEW RELEASE	H-15-21	EMILY

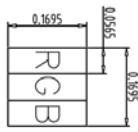

A Block

CNI

1	NC	21	LV3P
2	VDD	22	GND
3	VDD	23	LED_GND
4	VDD_EVID	24	LED_GND
5	SCL_EVID	25	LED_GND
6	SDA_EVID	26	NC
7	NC	27	LED_PWM
8	LVON	28	LED_EN
9	LVOP	29	NC
10	GND	30	NC
11	LV1N	31	LED_VCC
12	LV1P	32	LED_VCC
13	GND	33	LED_VCC
14	LV2N	34	NC
15	LV2P	35	BIST
16	GND	36	NC
17	LVGLN	37	NC
18	LVGLKP	38	NC
19	GND	39	NC
20	LV3N	40	NC

1	VDD
2	D+
3	D-
4	NC
5	GND
6	GND

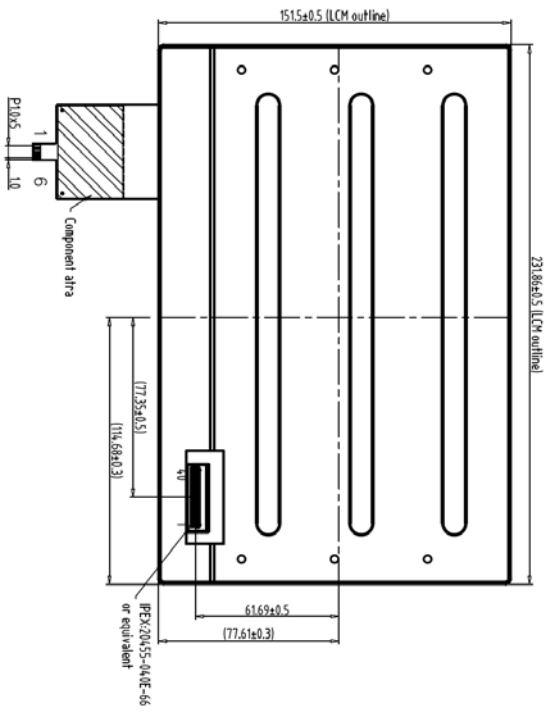

Back view

Note: 1. Unless indicated, Tolerance "±0.5"

1	IPEX:20455-040E-66 or equivalent	7		TOLERANCE GRADE(F)	A	B	DIM.	MM	DWN.	EMILY	DATE	
2		8					IR NO.		CHEK.		DATE	
3		9										
4		10					PARTS NO(LCM-1)		APPD.			
5		11					1280800W8-T					
6		12										

晶采光電科技
 TITLE
1280800W8-T
 DWG. NO. (10.1)
 *2104BSMA SHEET 1 OF 1